

No. 90651 GRID-DIP METER

I. GENERAL

The Millen 90651 Grid-Dip Meter may be used in any of the following manners:

1. Grid-dip oscillator for use as an oscillating frequency meter to determine the resonant frequency of de-energized r. f. circuits.

Plate potential is applied to the Grid-Dip Meter and it becomes an r. f. oscillator. A d.c. meter in the grid return indicates relative power. When a circuit, resonant at the oscillator frequency, is coupled to the "probe" inductance, power is absorbed from the oscillator by the resonant circuit and is so indicated by a dip (decrease) in the grid meter reading. The "Grid Dipper", employed in this manner, may then be used to check the resonant frequency of a circuit without the application of power to the circuit in question. This results in a considerable saving of time, and a definite assurance of correct frequency adjustment of a circuit is obtained. Circuits may be checked or retuned before completion of the unit in which they are to be used. Only minor trimming is generally required under actual operation. Guesswork or "cut and try" methods are eliminated. Possible damage to components during initial tune up and adjustment is eliminated.

II. METHODS OF COUPLING

Correct methods of coupling the grid-dip meter to circuits under tests are shown in Fig. 1. When used as a grid-dip oscillator harmonics of lumped-constant resonant circuits will not be indicated; however, other resonant frequencies are sometimes indicated. These will be due to other resonant circuits formed by circuit wiring, stray capacitances, etc. In most cases these will occur at a higher frequency. On the other hand, harmonics of antennas, transmission lines, etc. will be indicated as will be explained later in the text under the heading "antennas."

III. APPLICATIONS

Receiver tuned circuits. Use the instrument as a grid-dip oscillator. Remove power from the receiver and resonate each tuned circuit to the desired frequency as indicated by the meter dip. Gang tuned circuits should be aligned for tracking by checking at each end of the ganged range. A check at one or two points in between will also be helpful. Methods of electrically obtaining the desired bandspread or tracking will not be explained

2. Oscillating detector for determining the fundamental or harmonic frequencies of energized r.f. circuits.

Plate potential is applied and the instrument is used as an r.f. oscillator. Instead of observing the grid-meter reading, a pair of phones is inserted in the phone jack and an audible beat may be heard when the instrument is tuned to the fundamental or harmonic frequency of a source of r.f. The frequency may be read directly from the calibrated dial.

3. Signal generator. The instrument may be employed for this purpose generally in place of a standard signal generator, except where special shielding or a known r.f. output voltage is required.

4. Tuned r.f. diode or non-oscillating detector for use as an absorption-type frequency meter. No plate potential is applied and the internal tube is used as a diode. The grid meter is then in the diode load circuit and will read up-scale (current increase) when the instrument is tuned and closely coupled to a source of r.f. energy.

When looking for the grid dip, it will be noted that the grid current reading slowly varies as the dial is rotated; however, correct resonance is indicated when the meter takes a sharp or pronounced dip.

It is suggested that the user of the "Grid Dipper" at first set up test L/C combinations, short test antennas, etc., and check them with the instrument in order to become familiar with the coupling methods and with the general behavior and operation of the unit.

here. Reference may be made to any good radio text book.

Following the above procedure, power may be applied to the receiver and the grid-dip meter employed as a signal generator for checking final alignment. A very short antenna should be connected to the receiver input terminals and the "Grid Dipper" should be placed on the bench removed from nearby conductors,

and where body movements are least apt to affect the r.f. signal from the instrument. Some sort of indicating device such as an "S" meter or v.t.v.m. at the receiver detector must be used. If the r.f. signal is too strong, the receiver antenna may be shortened, or the instrument may be removed to a more remote or partially shielded location.

Where a superheterodyne type of receiver is involved and, if the receiver fails to function, it is quite possible that the receiver local oscillator is not working. This may be checked by employing the "Grid Dipper" as an r.f. diode detector or absorption type wave meter. Couple it to the oscillator coil and, if the meter does not go to scale when the instrument is tuned to the resonant frequency of the oscillator tank, the oscillator is not functioning. An alternative method having greater sensitivity and capable of more accurate frequency measurement is to use the instrument as an oscillating detector and listen for the local oscillator beat in the headphones.

Transmitter tuned circuits. Use the instrument as a grid-dip oscillator with plate power removed from transmitter and proceed to adjust tanks to desired frequency as with receiver circuits. Tubes should be in place, and where capacitive coupling is used between stages, the grid circuit associated with following tube should be completed.

After the above procedure, plate power may be applied and final alignment made according to grid and plate meter indications. R.f. power at correct frequency in each tank may be checked by employing the "Grid Dipper" as a diode absorption frequency meter or it may be utilized as an oscillating detector. Due to its greater sensitivity in the latter state, care must be taken not to mistake audible beats from some other energized r.f. circuit. This may be checked by moving the instrument closer to the circuit under test and noting whether or not the beat increases in volume. If it does, the beat heard is from the desired circuit. Harmonics also may be heard, so it is wise to check for the beat heard at the lowest frequency.

Neutralization. Employ the instrument as a grid-dip oscillator. Remove all plate power from the transmitter. Couple the "Grid Dipper" to grid tank of stage to be neutralized, or in the case of capacitive coupling to the preceding plate tank (it is assumed that the tank has already been tuned to correct frequency). Couple fairly close and leave instrument set in position with its meter deflected at bottom of

the resonant dip. Neutralization is then indicated when rotation of amplifier plate tank capacitor has no reaction on the deflected meter reading. Another method is to use the instrument as a diode absorption-type meter and proceed to neutralize in the manner normally employed when using absorption-type wavemeter, or as with similar indicating device, i.e.:

Remove plate power from amplifier stage to be neutralized, and apply power to stage driving the grid. Couple the "Grid Dipper" to the amplifier tank, tune the instrument to the driving frequency and check for the presence of r.f. in the tank as indicated by a rise in the "Grid Dipper" meter current. Adjust neutralizing capacitor until no reading is seen on the meter.

Parasitic oscillations. Apply power to transmitter and use instrument as an oscillating detector while listening on headphones for beat of parasitic oscillation. As an alternative, the parasitic frequency may be determined by using the instrument as a tuned r.f. diode or absorption type frequency meter. When parasitic frequency has thus been determined, as read from the "Grid Dipper" scale, remove power from transmitter and use instrument as a grid-dip oscillator to locate circuits or components, such as r.f. chokes, circuit wiring, etc., resonant at parasitic frequency.

Parallel resonant traps. Use as a grid-dip oscillator. Trap may be tuned or checked either before or after connecting it in desired circuit. If tuned before installation, adjustment will remain correct upon installation if its inductance is physically removed from other conductive components which may alter the inductance value. This is not usually the case, so further minor adjustment will probably be required after installation. When in the circuit, it is possible that its resonant frequency may be quite a bit off as indicated by the "Grid Dipper". Actually the trap itself will still be tuned to approximately correct frequency but the grid-dip oscillator reading may be found at some other frequency (usually lower) due to circuit "strays" across the trap.

Final precise adjustment may be made by applying power to circuit and by tuning trap under actual operation for desired effect. In many cases this will not be necessary as pre-tuning is quite accurate.

Series resonant traps. Follow same general procedure as with parallel resonant trap. To check or tune prior to installation, trap may be first connected as a parallel trap. At

high frequencies or where the trap inductance is low, the lead completing the parallel circuit should be of large wire or wide copper ribbon to keep its inductance low, and care should be taken not to permit this lead to be positioned so as to add stray capacitance. Leads to be used upon final installation must also be included when external measurements are being made.

R. F. chokes. To determine self resonance of r.f. chokes, use "Grid Dipper" as a grid dip oscillator.

Measure circuit Q. Use the "Grid Dipper" as signal generator. Connect a v.t.v.m. across the circuit to be measured. Couple instrument to circuit (Fig. 1A) and resonate for maximum, or peak reading, on v.t.v.m. Note frequency at which this occurs. Then shift the instrument each side of resonance to the frequency where the voltmeter reading drops to approximately 70.7% of that at resonance. Note the frequency of these two points and calculate the circuit Q from equation "A", Appendix 1, where f_r is the resonant frequency and Δf is the difference between the "off resonance" frequencies just found. The original coupling should be adjusted for a convenient maximum reading of the v.t.v.m. and then should be left fixed at this position for the remainder of the procedure.

When the circuit Q is quite high, it may be necessary to check the frequencies with a calibrated receiver, because the "off resonance" points will occur too closely together for accurate reading on the instrument scale.

Relative circuit Q at a given frequency. Use as a grid-dip oscillator and observe character of the dip whether broad or sharp. The sharper the dip, the higher the Q.

Measurement of capacitance. Several methods may be employed. All involve the use of the "Grid Dipper" as an oscillator.

A small jig (Fig. 2) must be made, into which may be plugged any one of the "Grid Dipper" coils.

To check an unknown capacitor, it is then only necessary to clip the jig, with a coil inserted, across the unknown capacitance. Find the resonant frequency and refer to the calibration chart for value of capacitor with the coil employed. For over-all accuracy, it is best to employ one of the coils from the medium frequency range.

Due to the distributed capacitance of the coils, a slight error will be encountered at very low capacitance measurements. Likewise, due to self inductance of large capacitors, a small error will be found when measuring these. Errors will be negligible for most practical purposes.

Measurements below 50 mmf are generally not obtainable because resonance at these values usually falls out of range of the coils left available for frequency checking. For measurements below 50 mmf an additional calibrated coil is required.

For these measurements, in a great number of cases, the capacitor need not be removed from the circuit in which it is wired unless the capacitor is heavily loaded.

Another method, similar to that above, is to employ a known inductance and find the resonant frequency with the unknown connected across it. See equation "B" Appendix 1 where f is the resonant frequency in cycles and L is the inductance in henries. C_x will be in farads.

A third method, for capacitors up to about 1000 mmf, requires an inductance which is shunted by a calibrated variable capacitor. The capacitor is set at maximum and the resonant frequency of the circuit is found. The unknown capacitor is then connected across the variable and the capacitance of the latter decreased to a point where the circuit resonates at the original frequency. The difference between the first and last settings of the calibrated variable capacitor is the value of the unknown.

Measurement of inductance of r.f. coils. Connect a capacitor of known value across the coil and use the "Grid Dipper" as a grid-dip oscillator to find the resonant frequency of the resulting L/C combination. The inductance of the coil may be calculated from equation "C" Appendix 1 where L_x is in henries, C is known capacitor in farads; or reference may be made to an L/C-resonance chart.

In measuring small values of inductance, be sure to employ a low inductance standard condenser, connected to the unknown coil by wide ribbon, in order to obtain most accurate results. Due to the distributed capacitance, especially in large coils, some slight error will result; however, if the value of the low inductance known capacitor is fairly high, the error will be negligible.

Relative Q of capacitors or inductances at a given frequency may be noted by observing

the character of the dip, as previously described.

Antennas. Use instrument as grid-dip oscillator. Coupling should be made at a low impedance or high current point as shown in Fig. 1E. This point, for a half wave antenna, is at the center, and for longer wires is at points odd quarter wavelengths measured from either end. It will be observed that a full-wave antenna will not be a half-wave at exactly half its resonant frequency. This is because the end effects are found only at the antenna ends and will be absent at other points when the antenna is a full wave or more long. It is therefore always necessary to measure an antenna under the conditions desired (relating to physical and electrical length). Measurement should be made with the antenna placed as near as possible to its ultimate operating position. Checks on a given antenna at different heights or positions will show an amazing difference in antenna resonance.

If it is physically impossible to reach a low impedance point, a check may be made at a high-impedance or high-voltage point. Capacitive coupling should be used as shown at Fig. 1F. If the high impedance point involved is one of the ends, the end effect will be altered due to the presence of the instrument and the resonant frequency of the antenna will slightly decrease. This must be taken into consideration when making measurement, i.e., the reading indicated will be slightly lower than true antenna resonance (with "Grid Dipper" away from end). This difference will be about 1 to 3% and will be encountered only when checking at the ends.

In all cases it is helpful to keep in mind the physical length in feet vs. electrical length (half-wave, full-wave, etc.) as calculated approximately by formula. Unlike lumped resonant circuits, antenna harmonics are detected when using the "Grid Dipper." As previously mentioned, these harmonics will not occur at exact multiples of a half-wave.

When measurement is made, the feeders should be disconnected from the antennas. Unless the feeders happen to be perfectly matched or terminated, true antenna resonance will not be indicated because unmatched feeders or incorrectly terminated feeders will present either a positive or negative reactance and will, therefore, alter the electrical length of the antenna.

When the antenna element is of very large diameter, such as is often found in rotating

beams, sufficient coupling to the "Grid Dipper" may not be obtained and some difficulty will be encountered in finding a reading. This condition may sometimes be relieved by jumping a foot or so of the antenna at the center with a small diameter wire and coupling to this wire.

If the antenna is to be normally used with its center open, close it with the shortest possible wire during measurement. This must be done also with the folded dipole. The short may later be removed, if required, when feeders are connected.

Tuned or resonant feeders, such as used in the Zepp antenna. Use instrument as grid-dip oscillator and check for desired resonance at the series or parallel tuned circuit on the transmitter end of the feeder. If resonance at the desired frequency is not obtainable, alterations may be made in the tuned circuit or the feeder length according to the actual resonant frequency found. Care must be exercised not to become confused by other resonance indications. It must be remembered that a Zepp is actually a long wire antenna partially doubled back on itself and resonance can therefore be noted at frequencies both higher and lower than the desired one.

Untuned or non-resonant feeders. After the antenna has been adjusted to the correct length, an untuned feed line may be connected employing some system of matching. Correct match may be obtained by making adjustment while employing a transmission impedance bridge or a standing-wave-ratio meter and using the "Grid Dipper" (set at antenna resonant frequency) as the signal generator.

The transmission bridge or the s-w-r meter should employ a meter of full scale sensitivity of 200 μ a or less, for most accurate readings. Coupling to the "Grid Dipper" should be as loose as possible consistent with obtaining sufficient reading. If the coupling is too tight, the instrument frequency calibration may be slightly shifted.

The matching device should then be adjusted for as near unity standing-wave-ratio as possible. If a satisfactorily low standing-wave-ratio is unobtainable, it is due to either a fault in the matching system or due to a shift in antenna resonance. The latter may be checked by slightly varying the "Grid Dipper" frequency until a lower s.w.r. is found or until a better s.w.r. meter null is indicated. The frequency at this point will be that of antenna resonance. If necessary, the antenna length

may then be changed until the correct standing-wave-ratio is realized at the desired frequency. It may also be necessary to trim up the adjustment of the matching system.

Tuning the parasitic beam. Use the instrument as grid-dip oscillator and adjust driven element for resonance. The feeder should be disconnected and the parasitic elements should be set at their calculated correct length. If the driven element is open at the center, close it. After this element has been properly set, connect and match feeder as described in the foregoing paragraph (open antenna center if matching system so requires). The parasitic elements may then be adjusted using the "Grid Dipper" as the signal generator coupled to the feed line and by observing readings on a receiver (with an "S" meter) connected to a short antenna some distance away. Relative field readings in actual "S" units then may be obtained after each adjustment. As when matching feeder coupling to the "Grid Dipper" should be as loose as possible. It is a good idea to occasionally check the actual frequency of the instrument on the receiver.

Following the tuning of the parasitic elements, the standing-wave-ratio should again be checked. It will, undoubtedly, increase, because tuning of the other elements will cause a change in antenna resonance. This will have to be altered accordingly, as described under "matching of non-resonant lines." Repetition of the preceding steps is advisable for putting on the finishing touches.

If the beam is located so that surrounding objects are likely to cause detuning as the beam is rotated (this may be checked during antenna and parasitic element tuning), it may be advisable to do the final retuning with the beam positioned either towards the direction in which it will be mostly used, or where the greatest degree of rotation has the least effect.

Needless to say, the transmitter may be used as the signal generator in place of the "Grid Dipper" during the above adjustments; however, the employment of the "Grid Dipper" for this purpose is more convenient, because the entire operation may be handled right on the roof by one person, or wherever the beam is located. The use of the instrument also keeps the channel free from unnecessary QRM.

Quarter-wave shorted lines. Use as a grid-dip oscillator and couple for open wire lines as at Fig. 1G, and for coaxial lines as at Fig. 1H. When trimming lines for correct length, fittings to be used eventually for connections should be

installed on the end of the line. The approximate frequency of the line may be determined by rough calculation. Other resonant points can be found, however. These will be at three times the fundamental quarter-wave, where the line is then three-quarter waves long, or five times the fundamental quarter-wave, etc.

Quarter-wave open lines. For open-wire lines, connect a short at one end and measure as for quarter-wave shorted line. Due to the length of the short, the actual electrical length of the line (used as an open line) will be slightly in error depending on the line spacing. The closer the spacing, the smaller the error.

For coax lines, place short on line and measure as quarter-wave shorted line. The short should be as direct and short as possible from inner conductor to shield in order to avoid errors. Fittings should also be included. Remove the short after measurements are completed.

Half-wave shorted lines. For open-wire lines, couple at center as shown at Fig. 1I. For coax line, measure for quarter-wave shorted line at half the calculated or desired frequency. Resonant frequency thus found must be then multiplied by 2 for a resulting half-wave shorted line.

Half-wave open lines. For open-wire lines, couple at center as shown at Fig. 1I. For coax line, short one end and measure for quarter-wave shorted line at half the calculated frequency. Resonant frequency thus found must be multiplied by 2 for the correct length of the line after short is removed; provided the short is made direct as mentioned above.

Check standing waves. Aside from employing the "Grid Dipper" as the signal generator in conjunction with a standing wave ratio meter, open-wire feed lines may be checked for the existence of standing waves by using the instrument as a diode detector. A flat line is indicated when the meter reading remains constant as the "probe" coil is moved along the line. Care must be used to maintain uniform distance or coupling between coil and line. Since the "Grid Dipper" coil is protected by an insulated sleeve, the coil form may be held against the line for maintaining uniform coupling.

This method is the same as that using a neon bulb, crystal detector or other similar device.

Relative field-strength meter. Use the "Grid Dipper" as diode detector. Connect a short antenna to one of the coil posts through

a 5-30 mmf capacitor. The instrument's frequency calibration will shift some, so the dial will have to be rotated for maximum reading of the received signal. Actual frequency calibration is unimportant for this purpose. Sensitivity of the "Grid Dipper" as a field meter is not as great as that of some other devices, but it will, nevertheless, be helpful in many cases.

The "Grid Dipper" may be employed for a number of other measurements, principally when utilized as a signal generator. Its use as a grid-dip oscillator will be quite obvious and self-suggestive for measurement of many other types of equipment and circuits. The applications herein described are those which will be generally most useful.

IV. POWER SUPPLY

The 90661-90651 is supplied complete with its own internal power supply. The unit will operate on 105 to 125 volts at 50 to 60 cycles per second. If it should become necessary to use the instrument where 115 volt, 60 cycle power is not readily available, it may be operated from a battery power supply.

Battery power should be connected to the terminal board, TB1, as indicated on the schematic circuit diagram, K 90661. The brown jumper between terminals 3 and 4 on TB 1b connects the oscillator tube heater to the 6.3 volt transformer winding. For battery operation, remove this jumper and connect positive 6 volts to terminal 4, the extreme left terminal. The heater battery supply needs to supply only 150 ma.

The red jumper between terminals 1 and 2 on TB 1a connects the internal B+ supply to the oscillator. For battery operations, remove the jumper and connect positive 67 to 125 volts to terminal 2, the terminal second from right.

The center terminal is ground and should have A-negative and B-negative connected to it. The cable connecting the battery power supply to the Grid-Dip Meter should be fed through the hole provided in the left side of the cover. This hole is normally covered with a plug button.

The FIL. and PLATE switches on the front panel control the battery supply as well as the a-c supply.

V. GROUND

The power cable on the 90661 Industrial Grid-Dip Meter is a three wire cable with a ground lead. The Grid-Dip Meter should be

connected to a point of zero potential (ground) whenever the unit is used in the vicinity of equipment on which high voltage is applied.

VI. MAINTENANCE

The entire unit is built on a single frame, therefore the cover on three sides may be removed simply by removing the four screws on the bottom.

If the unit does not operate, as indicated

by lack of meter reading, check first to be sure a coil is plugged into the coil terminals, and second check the fuse. If the fuse is defective check for short circuit in B+ or heater circuit before replacing fuse. Do not replace fuse with a fuse larger than 1½ amperes.

VII. LOW FREQUENCY USE

If it is desired to use the No. 90661 — No. 90651 at frequencies below 1.7 megacycles, the following additional coils may be procured:

No. 46702	925 to 2000 kc.
No. 46703	500 to 1050 kc.
No. 46701	325 to 600 kc.
No. 46705	220 to 350 kc.

VIII. COILS

Seven protected coils are supplied with the unit. The color-code on the coil base corres-

ponds with the color code on calibrated scale.

IX. TECHNICAL SUMMARY

Frequency Range: 1.7 to 80 megacycles in seven ranges with large over lap.

Size: 7 inches x 3 $\frac{1}{8}$ inches x 3 $\frac{3}{8}$ inches (less coils).

Weight: 3 $\frac{1}{2}$ pounds.

*Standard 500 Ohm
Tapered Pot
Tol. 10%*

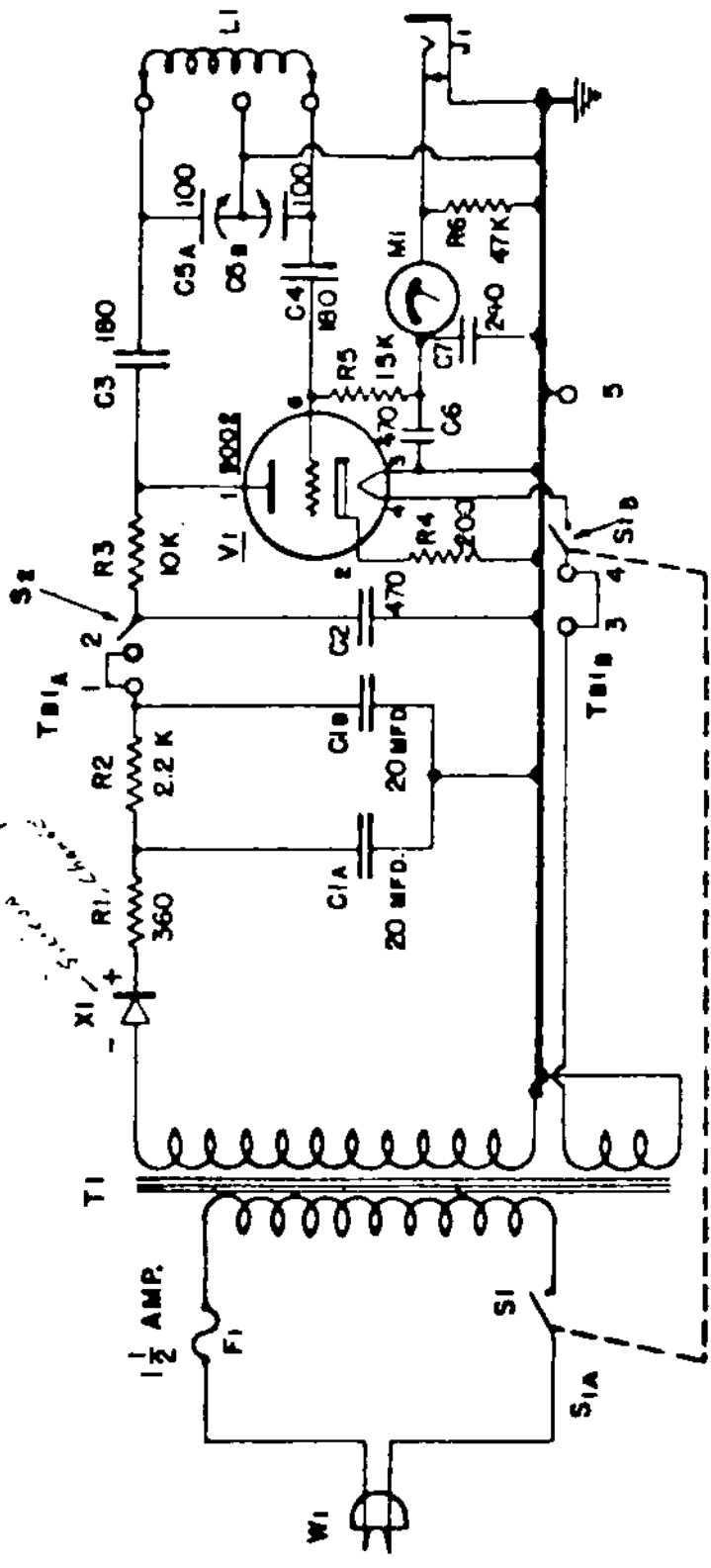

CAPACITIES IN MMFD. EXCEPT WHERE NOTED
K DENOTES 1000 OHMS

ALL DIMENSIONS UNLESS OTHERWISE NOTED MUST BE HELD TO A TOLERANCE OF

GRID-DIP METER	
FIRST MADE FOR	
DESIGNED BY	CHECKED BY <i>R.W.C.</i>
DRAWN BY <i>H. COTTERLY, JR.</i>	APPROVED
JAMES MILLEN MFG. CO., INC. MALDEN, MASS., U.S.A.	
K90651	DATE 8 - 24 - 49

H2050 (1) Added C7

HIGH FREQUENCY
HAIRPIN COIL COUPLED
AT SIDE.

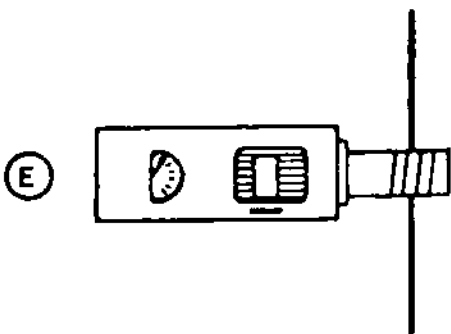
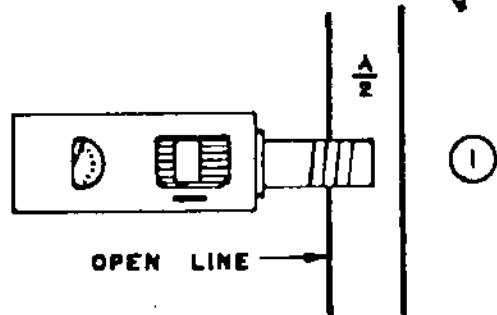
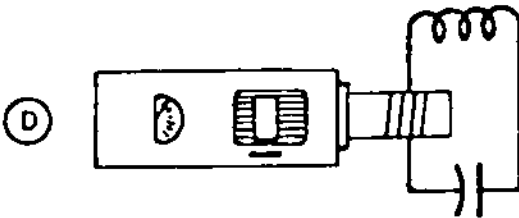
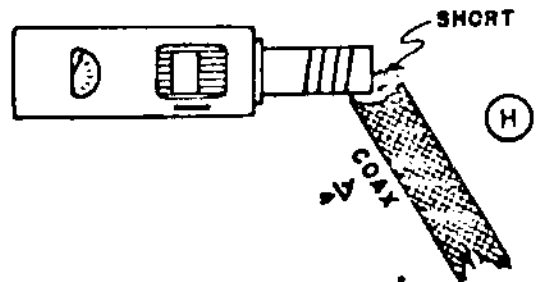
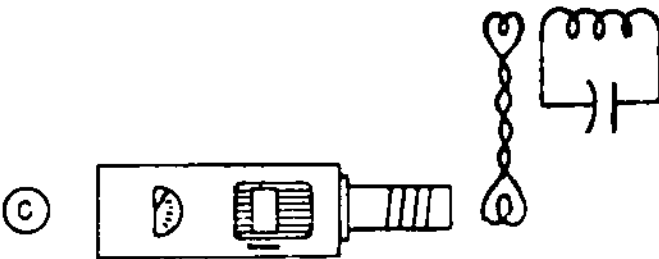
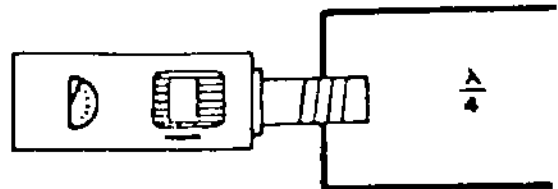
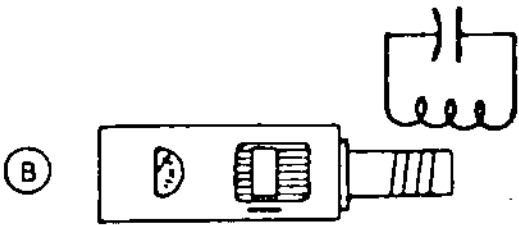
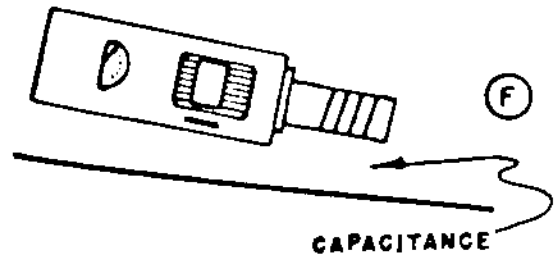
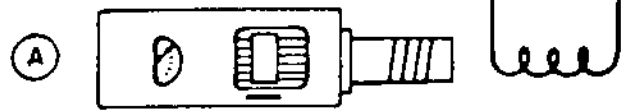

NOTE :
PROPER METHODS OF COUPLING THE
GRID - DIPPER TO CIRCUITS UNDER TEST.

ALL DIMENSIONS UNLESS OTHERWISE NOTED MUST BE HELD TO A TOLERANCE OF

FIG. (1)

FIRST MADE FOR

DESIGNED BY _____
DRAWN BY H. GOTTERLY

CHECKED BY *R.W.G.*
APPROVED _____

JAMES MILLEN MFG. CO., INC.
MALDEN, MASS., U.S.A.

K

DATE
5 - 3 - 49

APPENDIX I

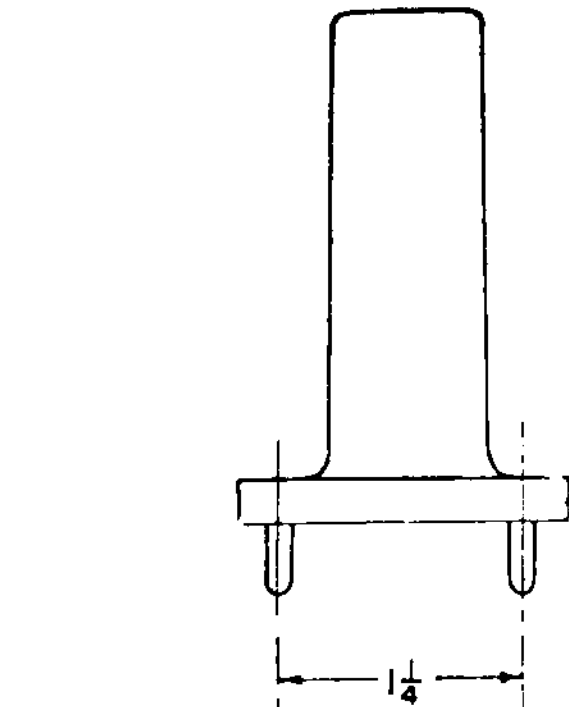

EQUATION

A

$$Q = \frac{Fr}{\Delta F}$$

EQUATION

B

$$C_x = \frac{1}{4 \pi^2 F^2 L}$$

EQUATION

C

$$L_x = \frac{1}{4 \pi^2 F^2 C}$$

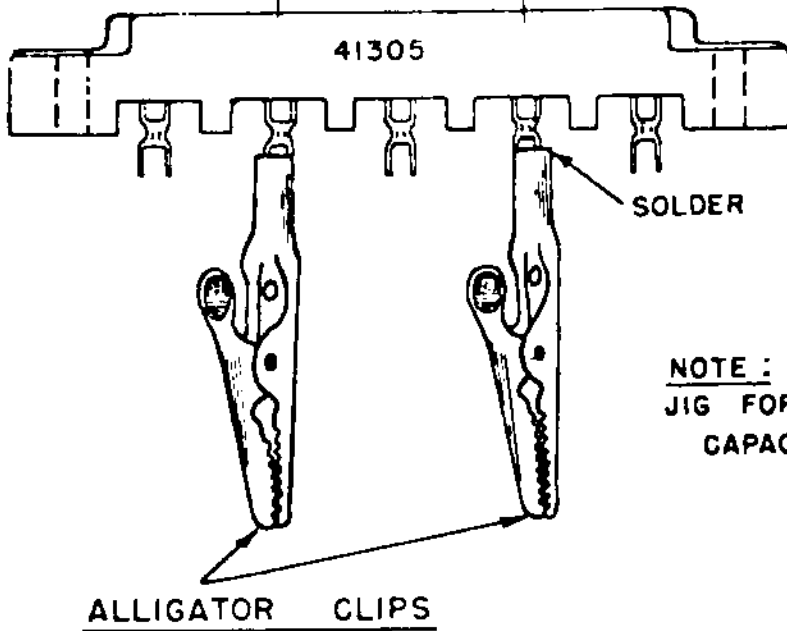

MILLEN
CATALOG NO.
41305

NOTE :
JIG FOR COILS USED IN
CAPACITANCE MEASUREMENTS

ALL DIMENSIONS UNLESS OTHERWISE NOTED MUST BE HELD TO A TOLERANCE OF

FIG. (2)

FIRST MADE FOR

DESIGNED BY _____
DRAWN BY H. GOTTERLY

CHECKED BY R.W.G.
APPROVED _____

JAMES MILLEN MFG. CO., INC.
MALDEN, MASS., U.S.A.

K

DATE
5 - 3 - 49

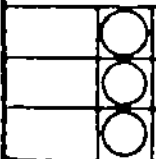

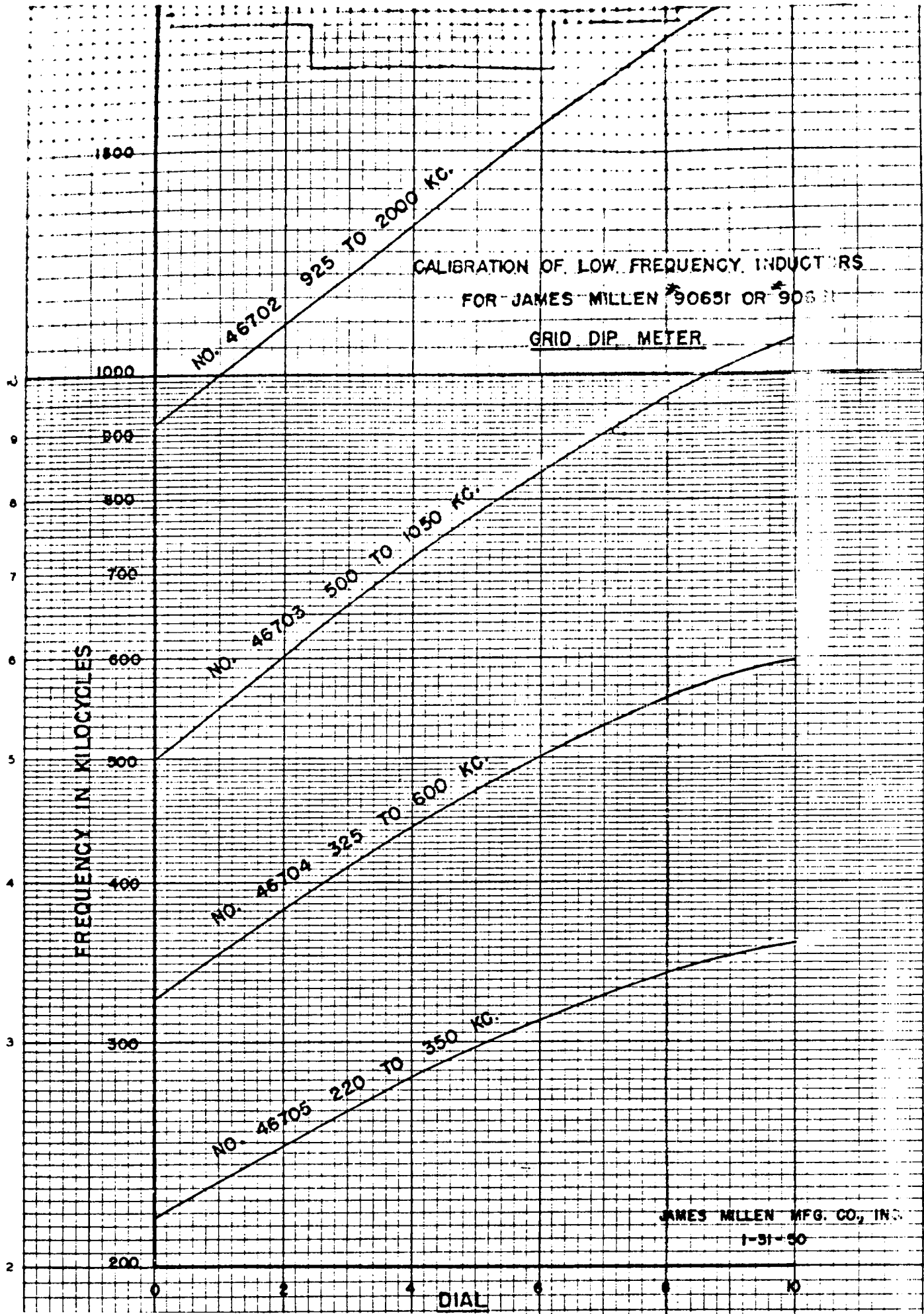

JAMES MILLEN MFG. CO., INC.

1-31-50

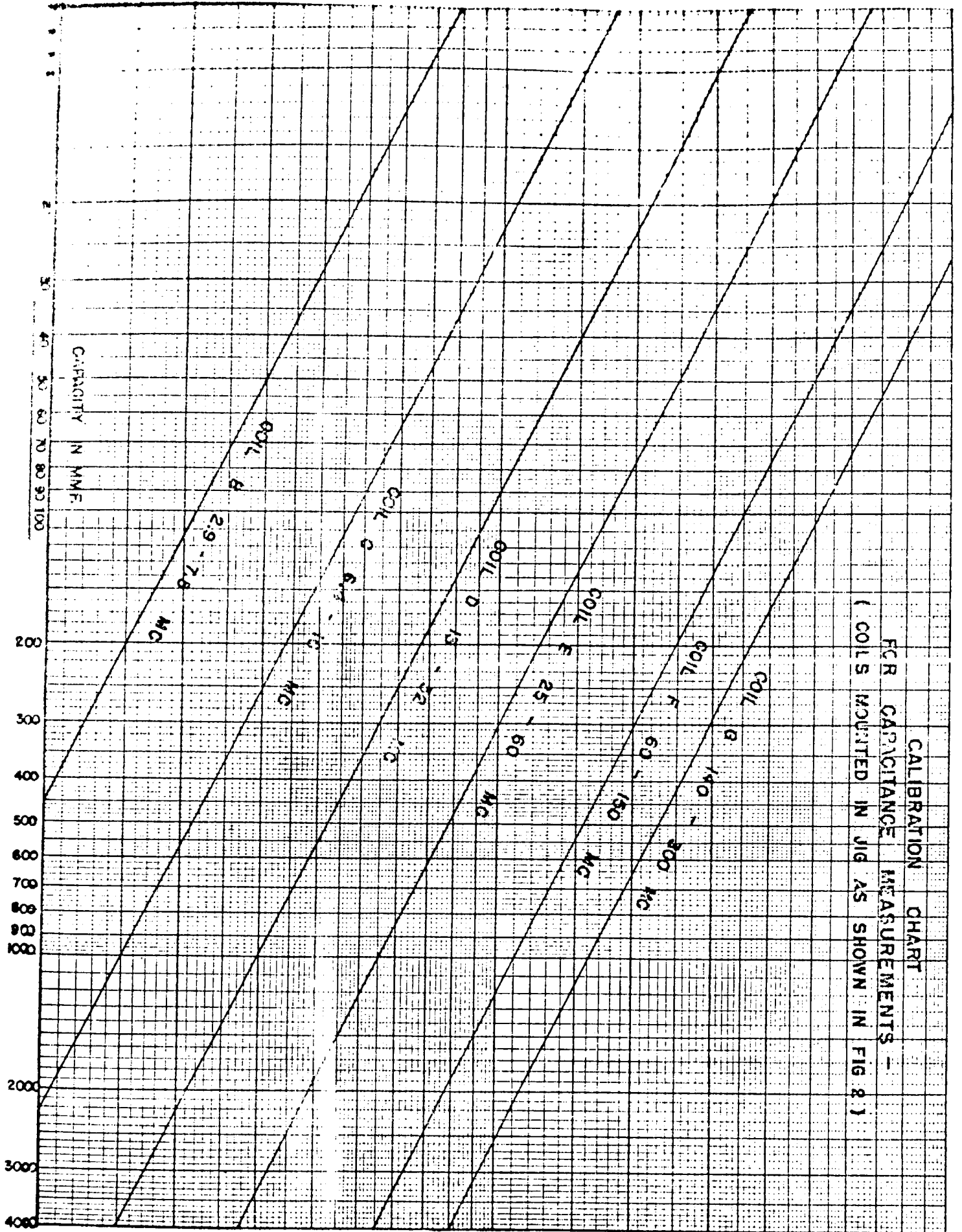

CALIBRATION CHART
 FOR CAPACITANCE MEASUREMENTS -
 (COILS MOUNTED IN JIG AS SHOWN IN FIG 2)

THIRD ANGLE PROJECTION

I. RESISTORS

- R₁ 360 \pm 5% 1/2 watt composition resistor
Allen Bradley Type EB
- R₂ 2.2K \pm 10% 1/2 watt composition resistor
Allen Bradley Type EB
- R₃ 10K \pm 10% 1/2 watt composition resistor
Allen Bradley Type EB
- R₄ 200 \pm 5% 1/2 watt composition resistor
Allen Bradley Type EB
- R₅ 15K \pm 10% 1/2 watt composition resistor
Allen Bradley Type EB
- R₆ 47K \pm 10% 1/2 watt composition resistor
Allen Bradley Type EB



II. CAPACITORS

- C₁ 20-20 mfd. - 150 WVDC - dual dry electrolytic
Aerovox No. E27A52
- C₂ 470 pf \pm 10% - 500 WVDC; button-mica; Erie No.370-FA
- C₃ 180 pf \pm 10% - 500 WVDC; button-mica; Erie No. 370-CB
- C₄ Same as C₃
- C₅ Millen condenser assembly for 90651
- C₆ Same as C₂
- C₇ 240 pf \pm 5% - 500 WVDC - Molded silver mica
Aerovox type CM20

III. Transformer

- T₁ Combined filament and plate transformer
N.Y.T. Co. No. TF-16838

DIMENSIONS UNLESS OTHERWISE NOTED MUST BE HELD TO A TOLERANCE OF

			PARTS LIST		
			DESIGNED BY	CHECKED BY <i>CQE</i>	SCALE
			DRAWN BY	APPROVED	
			JAMES MILLEN MFG. CO., INC.		DATE
			MALDEN  MASS., U.S.A.	3-25-65	K 90651 Grid Dip Meter

THIRD ANGLE PROJECTION

IV. RECTIFIER

X₁ 1N3756 - Silicon rectifier - max. forward current: 125 ma. -
 max. P.R.V.: 400
 (formerly selenium stack - Federal Tel. & Tel.
 No. 402D3452A)

V. TUBE

V₁ 9002 - 7-pin miniature triode

VI. SWITCHES

S₁ Filament switch - D.P.S.T. toggle - 3A. 125V.

S₂ Plate switch - S.P.S.T. toggle - 3A. 250V.

VII. METER

M₁ 0-1 milliamp - 2 1/2 inch dia. - Triplet model 221-T

VIII. COILS

L₁ Coil A Range 1.7 - 4.5 MC.
 Coil B Range 2.9 - 7.5 MC.
 Coil C Range 6.4 - 16 MC.
 Coil D Range 13-32 MC.
 Coil E Range 25-60 MC.
 Coil F Range 60-150 MC.
 Coil G Range 140 - 300 MC.

IX. SOCKET

V₁ Socket 7-pin miniature ceramic tube socket
 Millen No. 33407

DIMENSIONS UNLESS OTHERWISE NOTED MUST BE HELD TO A TOLERANCE OF

		PARTS LIST	
		DESIGNED BY	CHECKED BY <i>CQE</i>
		DRAWN BY	APPROVED
		JAMES MILLEN MFG. CO., INC.	DATE
		MALDEN  MASS., U.S.A.	3-25-65
			K 90651 Grid Dip Meter
			SCALE

X. PLUGS & JACKS

- W₁ 2 - conductor power cord;
~~Cornish Wire Co. No. 01299-002~~
- J₁ Phone jack - Mallory No. A2A

XI. FUSE

- F₁ 1 1/2 Amp. 250V. - Type 3AG



XII. MISCELLANEOUS

- Fuse holder; Cinch-Jones No. 801
- 4 lug terminal strip; Cinch-Jones No. 1542-A
- 2 lug terminal strip; Cinch-Jones No. 1520
- Etched panel per Millen drawing No. K90651-15
- Molded back plate per Millen drawing No. K90651-5
- Dial window per Millen drawing No. K90651-12
- Dial cross hair per Millen drawing No. 90651-14
- Paper dial
- Chassis cover (wraparound)
- Carrying case - Millen No. 90651-C

XIII. EXTERNAL HARDWARE

- Back plate: 4 No. 4-40 x 3/8" - binding head screws - B.N.P.*
- 2 No. 8-32 x 1/2" - binding head screws - B.N.P.*
- 4 No. 4 internal lockwashers - B.N.P.*
- 2 No. 8 flat fiber washers
- Etched panel: 3 No. 4 x 1/4" self-tapping screws
- S₁&S₂ : 2 7/16" I.D. flat metal washers - B.N.P.*
- 2 7/16"-32 hex nuts - B.N.P.*

DIMENSIONS UNLESS OTHERWISE NOTED MUST BE HELD TO A TOLERANCE OF

	PARTS LIST		
	DESIGNED BY	CHECKED BY <i>UGE</i>	SCALE
	DRAWN BY	APPROVED	
	JAMES MILLEN MFG. CO., INC.	DATE	K 90651 Grid Dip Meter
	 MALDEN MASS., U.S.A.	3-25-65	

THIRD ANGLE PROJECTION

J₁ : 1 3/8" I.D. flat metal washer - B.N.P.*
 1 3/8"-32 hex nut - B.N.P.*

Cabinet: 4 No. 6-32 x 1/4" binding head screws - B.N.P.*
 4 No. 6 internal lock washers - B.N.P.*
 1 snap button plug for 3/8" dia. hole.
 United-Carr No. 48186

*B.N.P.: brass, nickel-platd

DIMENSIONS UNLESS OTHERWISE NOTED MUST BE HELD TO A TOLERANCE OF

				PARTS LIST	
		DESIGNED BY	CHECKED BY	SCALE	
		DRAWN BY	APPROVED		
		JAMES MILLEN MFG. CO., INC.		DATE	K 90651 Grid Dip Meter
		MALDEN	 MASS., U.S.A.	3-25-65	